



ON Semiconductor®

<http://onsemi.com>

LA73031V

Monolithic Linear IC

Video Signal Input Switch for DVD Recorder

Overview

This LA73031V is a video signal input switch for DVD recorder.

Functions

- Six input switches × one channel
- Five input switches × two channels
- Keyed clamp
- 6dB amplifier
- 6MHz low pass filter
- Video signal detection
- Composite sync output
- Standby mode

Specifications

Maximum Ratings at $T_a = 25^\circ\text{C}$

Parameter	Symbol	Conditions	Ratings	Unit
Maximum supply voltage	$V_{CC \text{ max}}$		7.0	V
Allowable power dissipation	$P_d \text{ max}$	$T_a \leq 75^\circ\text{C}^*$	780	mW
Operating temperature	T_{opr}		-20 to +75	$^\circ\text{C}$
Storage temperature	T_{stg}		-40 to +150	$^\circ\text{C}$

* When mounted on a $114.3 \times 76.1 \times 1.6 \text{ mm}^3$ glass epoxy resin.

Stresses exceeding Maximum Ratings may damage the device. Maximum Ratings are stress ratings only. Functional operation above the Recommended Operating Conditions is not implied. Extended exposure to stresses above the Recommended Operating Conditions may affect device reliability.

Recommended Operating Conditions at $T_a = 25^\circ\text{C}$

Parameter	Symbol	Conditions	Ratings	Unit
Recommending operation voltage	V_{CC}		5.0	V
Operating voltage range	$V_{CC \text{ opr}}$		4.75 to 5.25	V
Input pin voltage application range	V_{IN}		-0.3 to $V_{CC \text{ opr}} + 0.3$	V

LA73031V

Electrical Characteristics at Ta = 25°C, VCCV = ±5.0V

Parameter	Symbol	Input signal				Output Point	Test Conditions	Ratings			Unit	Control Voltage Unit: V									
		Point	Signal	Freq [Hz]	Amplitude [p-p]			min	typ	max		V4	V7	V9	V17	V19	V21	V23	V25	V28	
Current dissipation	I _{CC1}					V _{CC1} V _{CC2} V _{CC3} V _{CC4}	Measure the sum of currents flowing into V _{CC1} , V _{CC2} , V _{CC3} and V _{CC4} with no signal.	60	75	90	mA	0	0	5	5	0	0	0	0	0	0
Current dissipation at standby mode	I _{CC2}					V _{CC1} V _{CC2} V _{CC3} V _{CC4}	Measure the sum of currents flowing into V _{CC1} , V _{CC2} , V _{CC3} and V _{CC4} at standby mode.	7.5	9	10.5	mA								5		
Output level of composite	C40	V _{IN40}	SG1		1V	T38	Measure the output sync tip level at T38.	0.7	0.8	0.9	V	0	5	5	0	0	0	0	0	0	5
	C42	V _{IN42}	SG1		1V	T38		0.7	0.8	0.9	V	0	5	5	5	0	0	0	0	0	5
	C44	V _{IN44}	SG1		1V	T38		0.7	0.8	0.9	V	0	5	5	0	5	0	0	0	0	5
	C1	V _{IN1}	SG1		1V	T38		0.7	0.8	0.9	V	0	5	5	5	5	0	0	0	0	5
	C3	V _{IN3}	SG1		1V	T38		0.7	0.8	0.9	V	0	5	5	0	0	5	0	0	0	5
Output level of chroma	C8	V _{IN8}	SG2		714mV	T31	Measure the output center level at T31.	1.9	2.2	2.5	V	0	5	0	0	0	0	0	0	0	5
	C10	V _{IN10}	SG2		714mV	T31		1.9	2.2	2.5	V	0	5	0	5	0	0	0	0	0	5
	C12	V _{IN12}	SG2		714mV	T31		1.9	2.2	2.5	V	0	5	0	0	5	0	0	0	0	5
	C14	V _{IN14}	SG2		714mV	T31		1.9	2.2	2.5	V	0	5	0	5	5	0	0	0	0	5
	C16	V _{IN16}	SG2		714mV	T31		1.9	2.2	2.5	V	0	5	0	0	0	5	0	0	0	5
Output level of Y	C18	V _{IN18}	SG3		1V	T29	Measure the output sync tip level at T29.	0.7	0.8	0.9	V	0	5	0	0	0	0	0	0	0	5
	C20	V _{IN20}	SG3		1V	T29		0.7	0.8	0.9	V	0	5	0	5	0	0	0	0	0	5
	C22	V _{IN22}	SG3		1V	T29		0.7	0.8	0.9	V	0	5	0	0	5	0	0	0	0	5
	C24	V _{IN24}	SG3		1V	T29		0.7	0.8	0.9	V	0	5	0	5	5	0	0	0	0	5
	C26	V _{IN26}	SG3		1V	T29		0.7	0.8	0.9	V	0	5	0	0	0	5	0	0	0	5
Pedestal level of component output	PC38	V _{IN6}	SG4		1V	T38	Measure the output pedestal level at T38 and T29.	2.2	2.3	2.4	V	5	5	0	0	0	0	0	0	0	5
	PC31	V _{IN8}	SG4		1V	T31		2.2	2.3	2.4	V	5	5	0	0	0	0	0	0	0	5
		V _{IN18}	SG3		1V																
6dB amp gain	G40H	V _{IN40}	SG1	100k	1V	T38	Measure the gain to input of each output. 20log(V _{OUT} /V _{IN})	5.5	6	6.5	dB	0	5	5	0	0	0	0	0	0	5
	G8H	V _{IN8}	SG1	100k	714mV	T31		5.5	6	6.5	dB	0	5	0	0	0	0	0	0	0	5
	G18H	V _{IN18}	SG1	100k	1V	T29		5.5	6	6.5	dB	0	5	0	0	0	0	0	0	0	5
0dB amp gain	G40L	V _{IN40}	SG1	100k	1V	T38	Measure the gain to input of each output. 20log(V _{OUT} /V _{IN})	-0.5	0	0.5	dB	0	0	5	0	0	0	0	0	0	5
	G8L	V _{IN8}	SG1	100k	714mV	T31		-0.5	0	0.5	dB	0	0	0	0	0	0	0	0	0	5
	G18L	V _{IN18}	SG1	100k	1V	T29		-0.5	0	0.5	dB	0	0	0	0	0	0	0	0	0	5
Frequency characteristics in LPF-off	F40	V _{IN40}	SG1	10M	1V	T38	Ga-Gb	-0.5	0	0.5	dB	0	5	5	0	0	0	0	0	0	5
	F8	V _{IN8}	SG1	10M	714mV	T31	Ga=20log(V _{OUT} /V _{IN}) for 100kHz	-0.5	0	0.5	dB	0	5	0	0	0	0	0	0	0	5
	F18	V _{IN18}	SG1	10M	1V	T29	Gb=20log(V _{OUT} /V _{IN}) for 10MHz	-0.5	0	0.5	dB	0	5	0	0	0	0	0	0	0	5
Frequency characteristics in LPF-on1	F40LP1	V _{IN40}	SG1	6M	1V	T38	Ga-Gb	-3	-1	0.5	dB	0	5	5	0	0	0	0	0	0	0
	F8LP1	V _{IN8}	SG1	6M	714mV	T31	Ga=20log(V _{OUT} /V _{IN}) for 100kHz	-3	-1	0.5	dB	0	5	0	0	0	0	0	0	0	0
	F18LP1	V _{IN18}	SG1	6M	1V	T29	Gb=20log(V _{OUT} /V _{IN}) for 6MHz	-3	-1	0.5	dB	0	5	0	0	0	0	0	0	0	0

Continued on next page

LA73031V

Continued from preceding page.

Parameter	Symbol	Input signal				Output Point	Test Conditions	Ratings			Unit	Control Voltage Unit: V							
		Point	Signal	Freq [Hz]	Amplitude [p-p]			Min	Typ	Max		V4	V7	V9	V17	V19	V21	V23	V25
Frequency characteristics in LPF-on2	F40LP2	V _{IN40}	SG1	14.3M	1V	T38	Ga-Gb	-40	-30	dB	0	5	5	0	0	0	0	0	0
	F8LP2	V _{IN8}	SG1	14.3M	714mV	T31	Ga=20log(V _{OUT} /V _{IN}) for 100kHz	-40	-30	dB	0	5	0	0	0	0	0	0	0
	F18LP2	V _{IN18}	SG1	14.3M	1V	T29	Gb=20log(V _{OUT} /V _{IN}) for 14.3MHz	-40	-30	dB	0	5	0	0	0	0	0	0	0
Output 2nd order distortion	H40	V _{IN40}	SG1	5M	1V	T38	Measure the output 2nd harmonics component of 5MHz.	-45	-35	dB	0	5	5	0	0	0	0	0	0
	H8	V _{IN8}	SG1	5M	714mV	T31		-45	-35	dB	0	5	0	0	0	0	0	0	0
	H18	V _{IN18}	SG1	5M	1V	T29		-45	-35	dB	0	5	0	0	0	0	0	0	0
C.SYNC Separator output high level	CV40H	V _{IN40}	SG3		1V	T34	Measure the output high level at T34.	V _{CC} -0.5		V _{CC}	V	0		5	0	0	0	0	0
C.SYNC Separator output high level	CV40L	V _{IN40}	SG3		1V	T34	Measure the output low level at T34.	0	0.3	0.6	V	0		5	0	0	0	0	0
C.Sync separator output pulse delay time	CT40	V _{IN40}	SG3		1V	T34	Measure the pulse delay for input signal at T34.	0.85	1.2	1.6	μs	0		5	0	0	0	0	0
C.Sync separator output pulse width	CW40	V _{IN40}	SG3		1V	T34	Measure the pulse width at T34.	3.2	4.2	5.2	μs	0		5	0	0	0	0	0
V.Sync separator output high level	VV40H	V _{IN40}	SG6		1V	T36	Measure the output high level at T36.	V _{CC} -0.5		V _{CC}	V	0		5	0	0	0	0	0
V.Sync separator output low level	VV40L	V _{IN40}	SG6		1V	T36	Measure the output low level at T36.	0	0.3	0.6	V	0		5	0	0	0	0	0
V.Sync separator output pulse delay time	VT40	V _{IN40}	SG6		1V	T36	Measure the pulse delay for input signal at T36.	11	19	27	μs	0		5	0	0	0	0	0
V.Sync separator output pulse width	VW40	V _{IN40}	SG6		1V	T36	Measure the pulse width at T36.	150	190	240	μs	0		5	0	0	0	0	0
V-DET output high level	VDET40	V _{IN40}	SG1		1V	T43	Input signal	V _{CC} -0.5		V _{CC}	V	0		5	0	0	0	0	0
V-DET output low level						T43	No signal	0	0.3	0.6	V	0		5	0	0	0	0	0
DG	DGLP38	V _{IN40}	SG5	3.58M	1V	T38		-2	0	2	%	0	5	5	0	0	0	0	0
DP	DPLP38	V _{IN40}	SG5	3.58M	1V	T38		-1.5	0	1.5	deg	0	5	5	0	0	0	0	0
Crosstalk CVBS	CTCV	V _{IN40}	GND	5M	1V	T38		-60	-55	dB	0	5	5	0	0	0	0	0	0
		V _{IN42}	SG1																
Crosstalk C	CTC	V _{IN8}	GND	5M	714mV	T31		-60	-55	dB	0	5	0	0	0	0	0	0	0
		V _{IN10}	SG2																
Crosstalk Y	CTY	V _{IN18}	GND	5M	1V	T29		-60	-55	dB	0	5	0	0	0	0	0	0	0
		V _{IN20}	SG3																
Video S/N	SN40	V _{IN40}	SG3		1V	T38	BW = HPF100kHz, LPF5MHz 20log (noise/signal)	-65	-60	dB	0	5	5	0	0	0	0	0	0

LA73031V

Package Dimensions

unit : mm (typ)

3277

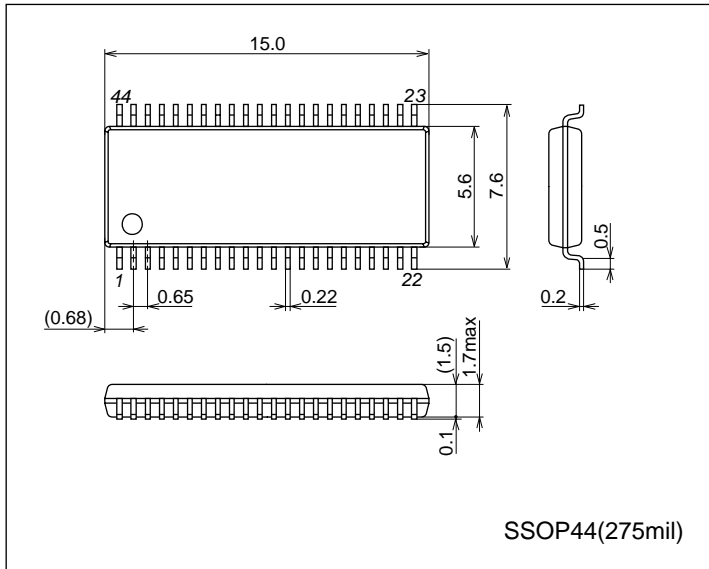

Control Specification

Pin control voltage Low level: 0 to 0.7V, High level: 2.6 to 5V

Input selection control

PIN21	PIN19	PIN17	PIN9	PIN4	PIN23	Output			
INSEL3	INSEL2	INSEL1	YOUTSEL	COMPONENT	Stand-by	CVBSOUT	Y OUT	C OUT	C.SYNC
L	L	L	L	L	L	CVBS1	Y1	C1	Y1
L	L	H	L	L	L	CVBS2	Y2	C2	Y2
L	H	L	L	L	L	CVBS3	Y3	C3	Y3
L	H	H	L	L	L	CVBS4	Y4	C4	Y4
H	L	L	L	L	L	CVBS5	Y5	C5	Y5
L	L	L	H	L	L	CVBS1	CVBS1	C1	CVBS1
L	L	H	H	L	L	CVBS2	CVBS2	C2	CVBS2
L	H	L	H	L	L	CVBS3	CVBS3	C3	CVBS3
L	H	H	H	L	L	CVBS4	CVBS4	C4	CVBS4
H	L	L	H	L	L	CVBS5	CVBS5	C5	CVBS5
				H	L	Cb	Y1	Cr (C1)	Y1
					H				CVBS2/Y2 (*1)

Other Controls

Pin No	Control item	L control	H control
7	Gain-CTL	0dB	6dB
28	LPF ON/OFF	ON	OFF

*1: At the time of standby, if a signal is in Y2, the sync of the signal of Y2 will be separated.

Standby mode

CVBS2	Y2	C.Sync output
Input	No Input	CVSB2
Input	Input	Y2
No Input	Input	Y2

*2: Since Pin25 is test mode control, please apply GND level.

Block Diagram and Application Circuit Example

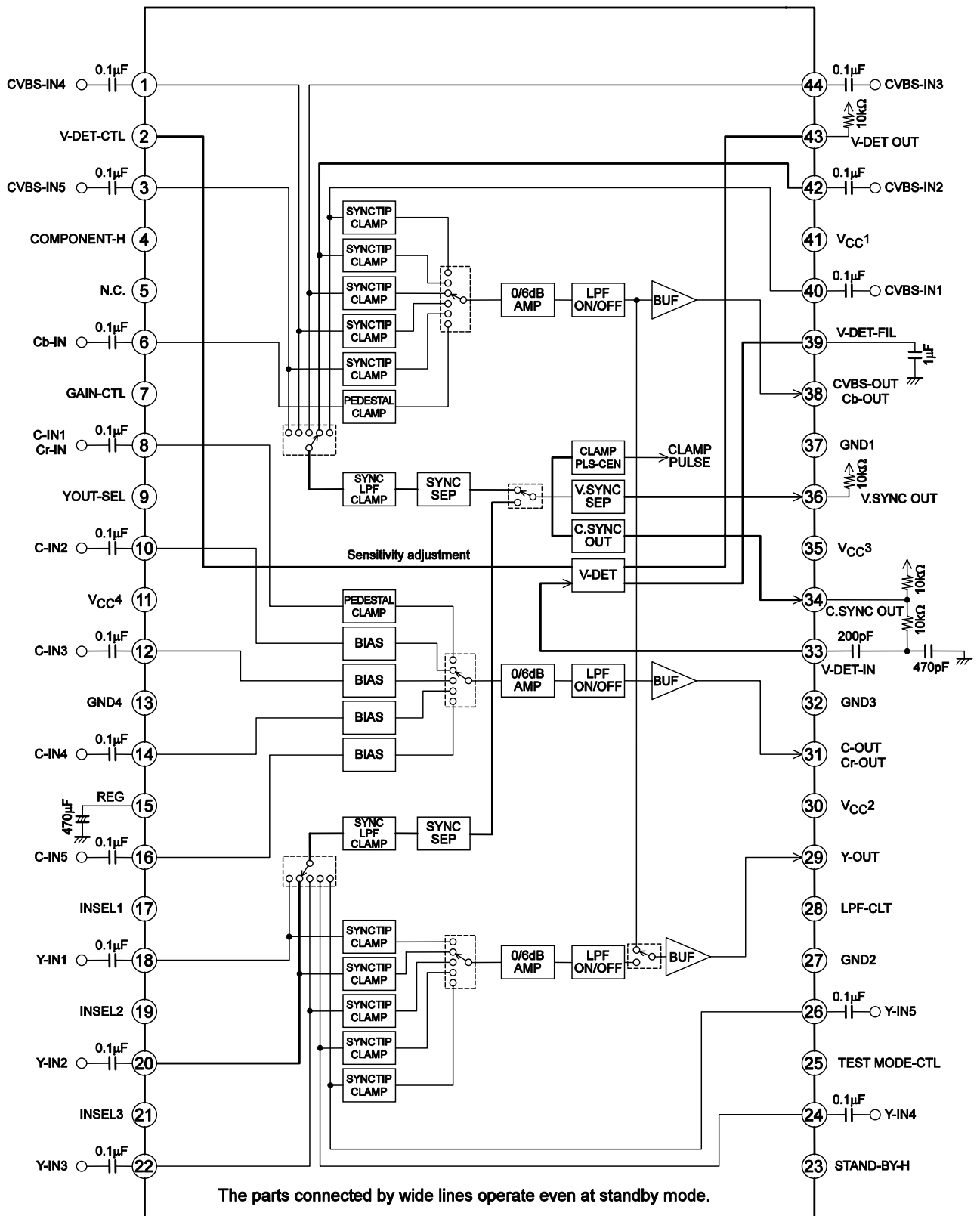

LA73031V

Pin Functions

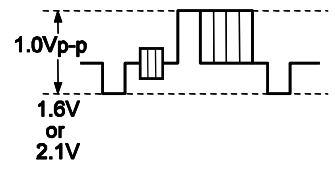
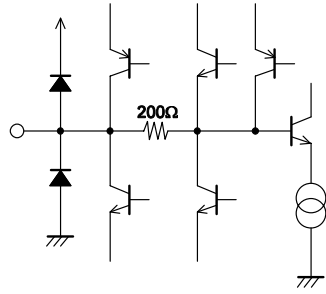
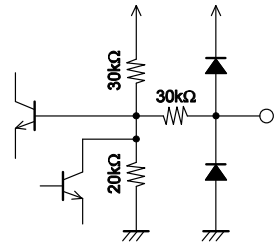
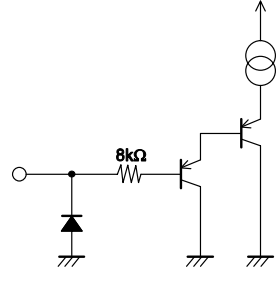
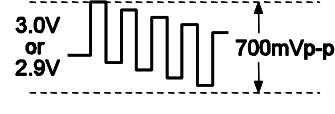
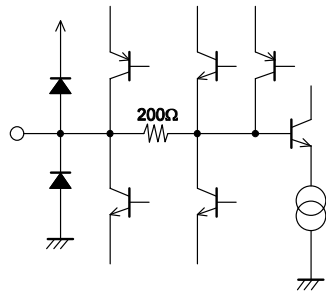
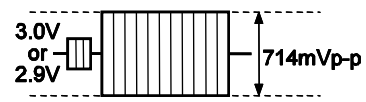
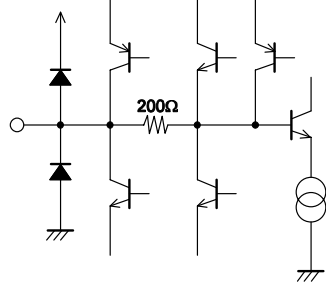
Pin No.	Pin name	Signal wave form	DC voltage AC level	Equivalent circuit
1 3 40 42 44	CVBS-IN4 CVBS-IN5 CVBS-IN1 CVBS-IN2 CVBS-IN3	 <p>1.0Vp-p 1.6V or 2.1V</p>	0dB: 1.6V 6dB: 2.1V	
		DC	No signal: 1.6V	
2	V-DET-CTL	DC	1.7 to 2.0V	
4	COMPONENT-H	DC	Except component mode: 0V Component mode: 5V	
7	GAIN-CTL	DC	0dB: 0V 6dB: 5V	
9	Y-OUT-SEL	DC	Y output: 0V CVBS output :5V	
17 19 21	INSEL1 INSEL2 INSEL3	DC	Low: 0V High: 5V	
23	STAND-BY-H	DC	Normal mode: 0V Standby mode: 5V	
28	LPF-CTL	DC	LPF-ON: 0V LPF-OFF: 5V	
6	Cb-IN	 <p>3.0V or 2.9V 700mVp-p</p>	0dB: 3.0V 6dB: 2.9V	
		DC	No signal: 1.6V	
8	C-IN1/ Cr-IN	 <p>3.0V or 2.9V 714mVp-p</p>	0dB: 3.0V 6dB: 2.9V	
		DC	No signal: 1.6V	

Continued on next page.

LA73031V

Continued from preceding page.

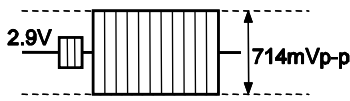
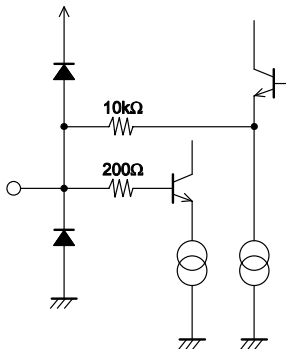
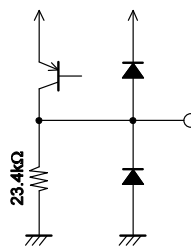
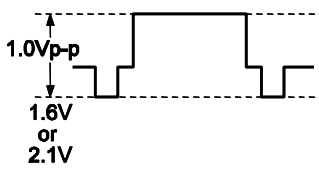
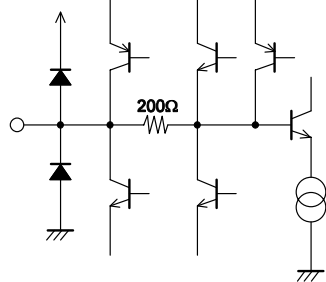
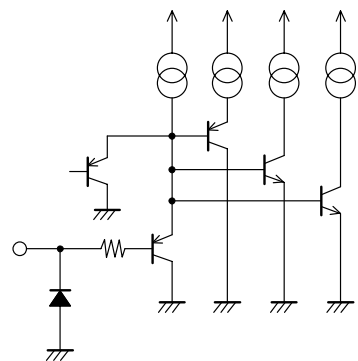
Pin No.	Pin name	Signal wave form	DC voltage AC level	Equivalent circuit
10 12 14 16	C-IN2 C-IN3 C-IN4 C-IN5	 <p style="text-align: center;">2.9V 714mVp-p</p>	2.9V	
		DC	No signal: 2.9V	
11 30 35 41	V _{CC} 4 V _{CC} 2 V _{CC} 3 V _{CC} 1			
13 27 32 37	GND4 GND2 GND3 GND1			
15	REG	DC	2.5V	
18 20 22 24 26	Y-IN1 Y-IN2 Y-IN3 Y-IN4 Y-IN5	 <p style="text-align: center;">1.0Vp-p 1.6V or 2.1V</p>	0dB: 1.6V 6dB: 2.1V	
		DC	No signal: 1.6V	
25	TEST MODE-CTL		GND	

Continued on next page.

LA73031V

Continued from preceding page.

Pin No.	Pin name	Signal wave form	DC voltage AC level	Equivalent circuit
29	Y-OUT		0.8V	
31	C-OUT/ Cr-OUT		2.3V	
38	CVBS-OUT/ Cb-OUT		CVBS output: 0.8V Component output: 2.3V	
33	V-DET-IN			
34 36	C.SYNC OUT V.SYNC OUT			
43	V-DET OUT	DC	No signal: 0.3V Input signal: 5V	
39	V-DET-FIL	DC		

Test Circuit

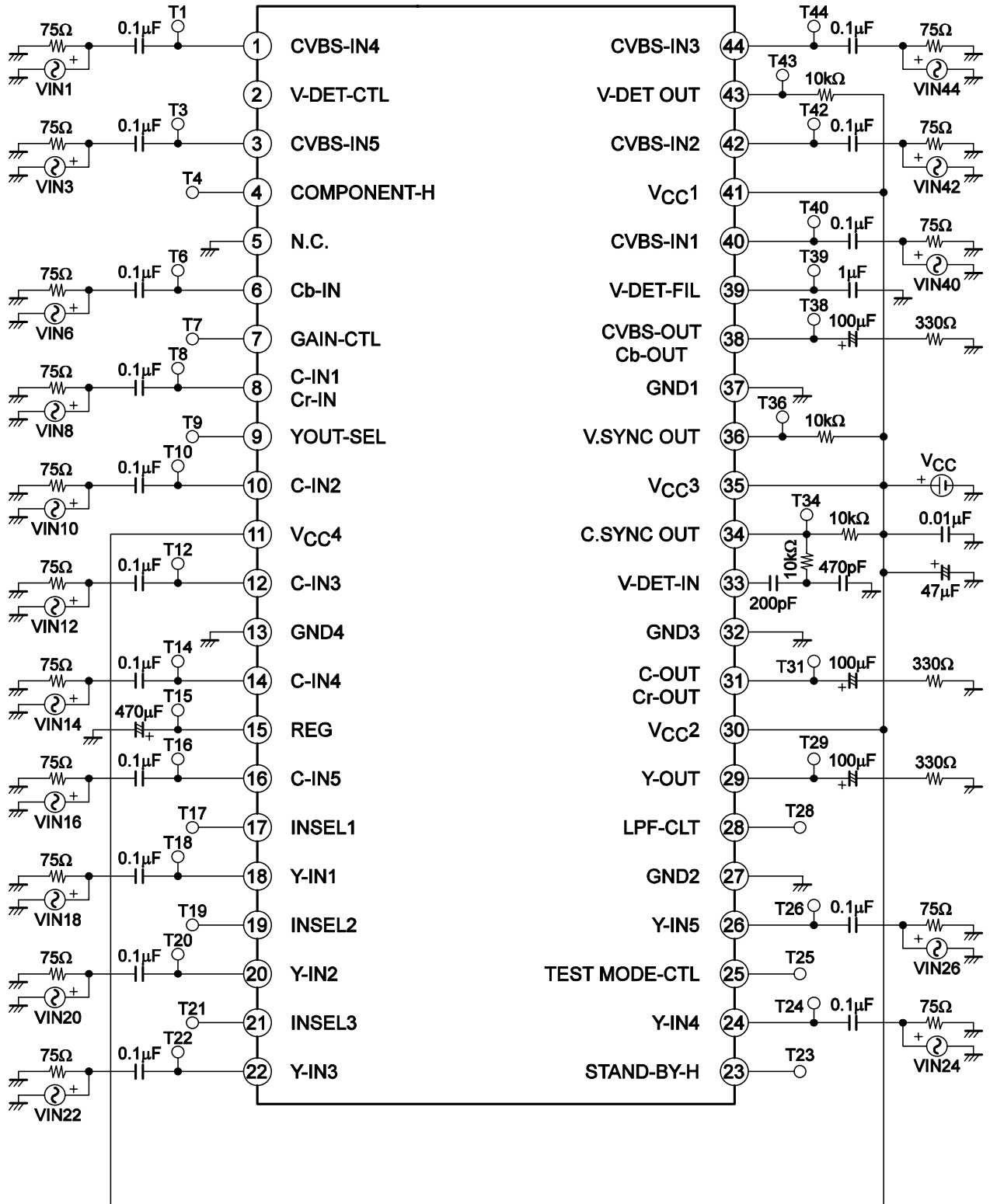

Input Signal

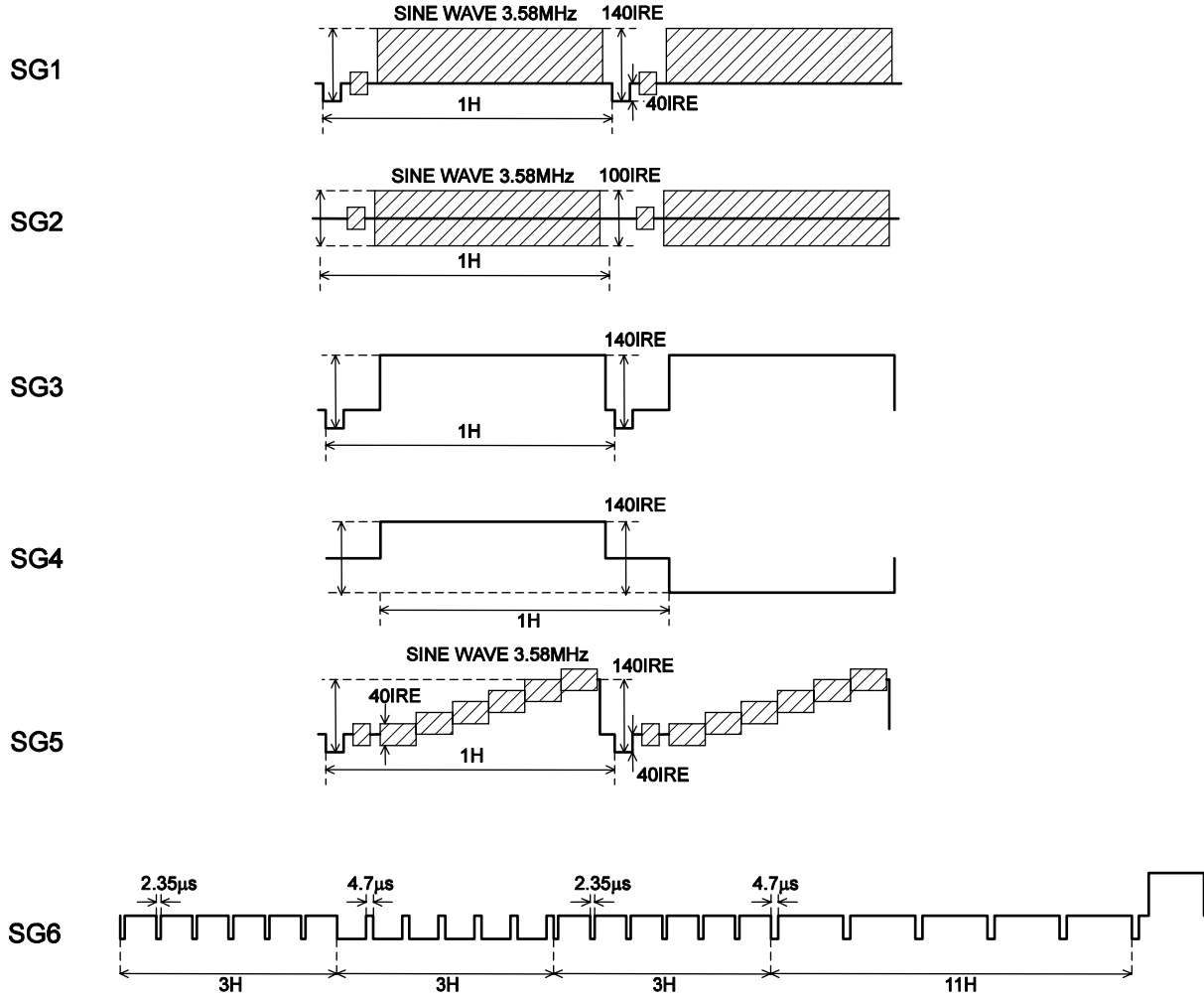

ON Semiconductor and the ON logo are registered trademarks of Semiconductor Components Industries, LLC (SCILLC). SCILLC owns the rights to a number of patents, trademarks, copyrights, trade secrets, and other intellectual property. A listing of SCILLC's product/patent coverage may be accessed at www.onsemi.com/site/pdf/Patent-Marking.pdf. SCILLC reserves the right to make changes without further notice to any products herein. SCILLC makes no warranty, representation or guarantee regarding the suitability of its products for any particular purpose, nor does SCILLC assume any liability arising out of the application or use of any product or circuit, and specifically disclaims any and all liability, including without limitation special, consequential or incidental damages. "Typical" parameters which may be provided in SCILLC data sheets and/or specifications can and do vary in different applications and actual performance may vary over time. All operating parameters, including "Typicals" must be validated for each customer application by customer's technical experts. SCILLC does not convey any license under its patent rights nor the rights of others. SCILLC products are not designed, intended, or authorized for use as components in systems intended for surgical implant into the body, or other applications intended to support or sustain life, or for any other application in which the failure of the SCILLC product could create a situation where personal injury or death may occur. Should Buyer purchase or use SCILLC products for any such unintended or unauthorized application, Buyer shall indemnify and hold SCILLC and its officers, employees, subsidiaries, affiliates, and distributors harmless against all claims, costs, damages, and expenses, and reasonable attorney fees arising out of, directly or indirectly, any claim of personal injury or death associated with such unintended or unauthorized use, even if such claim alleges that SCILLC was negligent regarding the design or manufacture of the part. SCILLC is an Equal Opportunity/Affirmative Action Employer. This literature is subject to all applicable copyright laws and is not for resale in any manner.